

# BUCK

## Uputstvo za montažu Istruzioni di montaggio Mounting instructions Montageanleitung Инструкция по монтажу

Instalaciju svetiljke i eventualnu zamenu oštećenog provodnika može da izvrši isključivo kvalifikovano lice ili lice koje odredi proizvođač ili njegov ovlašćeni predstavnik.

L'installazione di questo apparecchio o un'eventuale cambiamento del cavo danneggiato può essere fatto esclusivamente da una persona qualificata o una persona nominata dal Produttore o un suo rappresentante ufficiale.

The installation of this luminaire or potential replacement of the damaged cable can only be performed by a qualified person or a person determined by the Manufacturer or its official representative.

Die Installation dieser Leuchte oder der Ersatz beschädigter Kabel kann nur von einer qualifizierten Person oder einer vom Hersteller bevollmächtigten Person, durchgeführt werden.

Монтаж светильника или замену поврежденного провода должно осуществлять только квалифицированное за это лицо, либо лицо, которое укажет производитель или его представитель.

Sačuvati ovo uputstvo za slučaj održavanja i demontaže.

Conservare le istruzioni di montaggio per eventuali operazioni di manutenzione o smontaggio.

Bewahren Sie diese Montageanleitung für eine eventuelle Wartung oder Demontage auf.

Store these mounting instructions for any future maintenance or demounting.

Не выбрасывайте инструкцию, она Вам может понадобиться при эксплуатации или демонтажу светильника.

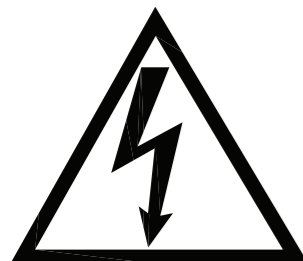

- Isključiti struju pri montaži.
- Togliere corrente prima di iniziare.
- Stromversorgung abschalten während der Montage.
- Disconnect power supply while mounting.
- Перед началом монтажа отключить электропитание.

BUCK d.o.o Milorada Jovanovića 9, 11147 Belgrade, Serbia

Tel: +381 11 2052 400; Fax: +381 11 2052 401

www.buck.lighting; e-mail: office@buck.lighting

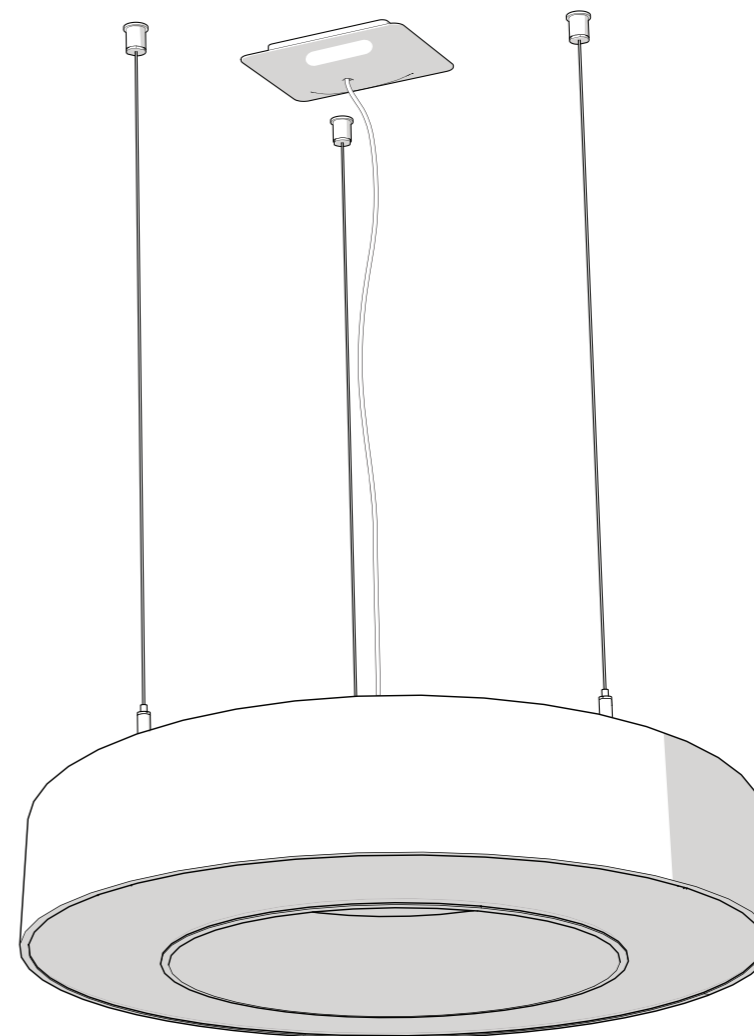

	X
400	330
650	550
950	800
1250	1100

## LUNA RING / S

**1**

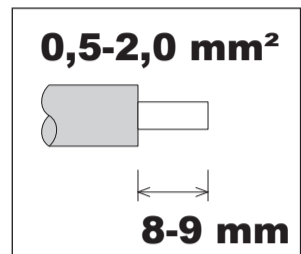
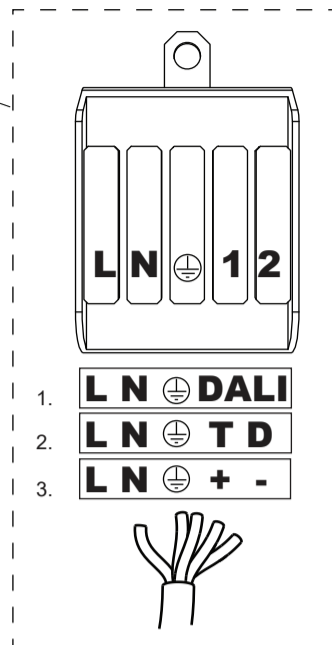
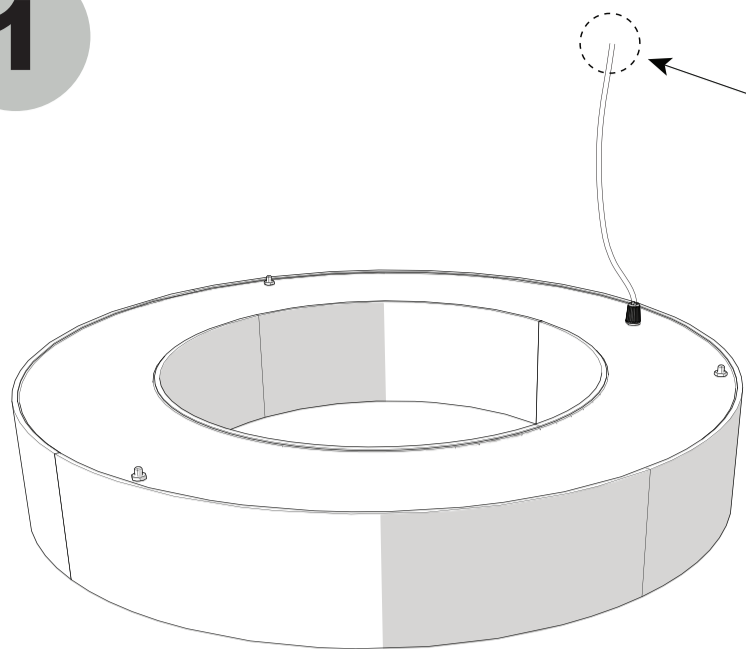

**2**

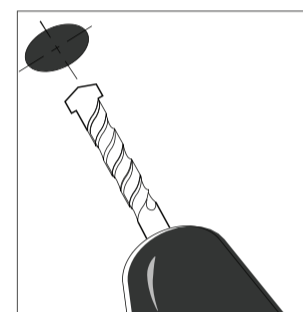
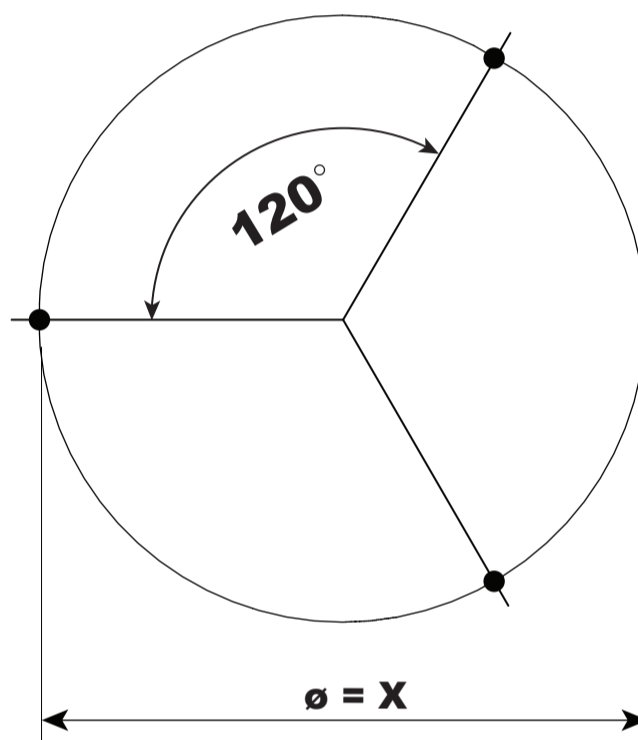
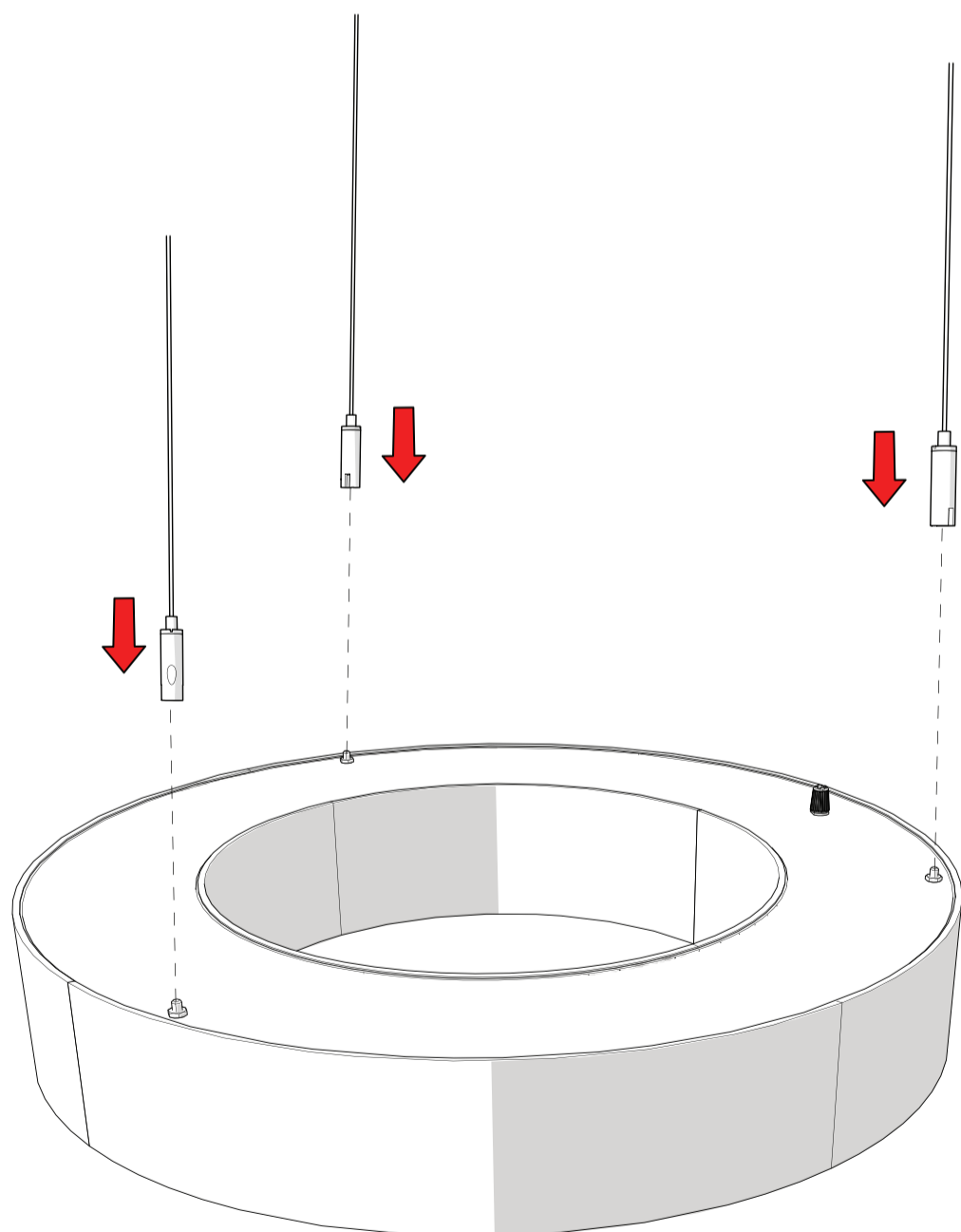

**3**

